

tolomeo tavolo

design: michele de lucchi, giancarlo fassina - 1987, 1991, 1999, 2005, 2006



Struttura a bracci mobili in alluminio lucidato, diffusore orientabile in tutte le direzioni, in alluminio anodizzato opaco, snodi e supporti in alluminio brillantato. Sistema di equilibratura a molle. Disponibile in quattro versioni, ognuna di esse con un supporto intercambiabile: base tavolo in alluminio lucidato, morsetto o perno fisso per scrivania in alluminio brillantato. Emissione di luce diretta orientabile, particolarmente adatta per l'utilizzo in prossimità di videotermini per il modello Tolomeo video e Tolomeo mini video. Colori: Tolomeo, Tolomeo mini, Tolomeo video: alluminio o nero. Tolomeo micro: alluminio, nero, rosso, grigio fumé, turchese, giallo, bronzo, arancio, verde, blu.

Cantilevered structure in polished aluminium; fully rotational diffuser in matt anodised aluminium, joints and supports in polished aluminium. System of spring balancing. Available in four versions, each with an interchangeable support: table base, clamp or desk fixed support in polished aluminium. Direct adjustable light emission for Tolomeo Video models particularly suitable for use with VDU terminals.

Colori: Tolomeo, Tolomeo mini, Tolomeo video: alluminio o nero. Tolomeo micro: alluminio, black, red, grey blue, yellow, bronze, orange, green, turquoise, blue.

Structure à bras articulé en aluminium poli, diffuseur, orientable dans toutes les directions, en aluminium anodisé, rotules et supports en aluminium brillant. Système d'équilibrage à ressorts. Disponible en quatre versions, chacune d'entre elles avec accessoire interchangeable: base ronde en aluminium poli, étau ou pivot en aluminium brillant. Emission lumineuse directe orientable, particulièrement indiquée pour une utilisation près de terminaux informatiques pour les modèles Tolomeo Video et Tolomeo mini video. Couleurs: Tolomeo, Tolomeo mini, Tolomeo video: aluminium ou noir. Tolomeo micro: aluminium, noir, rouge, gris fumé, turquoise, jaune, bronze, orange, vert, bleu.

Ausrichtbare Arme aus glänzendem Aluminium, in alle Richtungen verstellbarer Kopf aus matt-eloxiertem Aluminium, Gelenke und Halterungen aus poliertem Aluminium mit Federausgleichsystem. Mit drei auswechselbaren Halterungen erhältlich: Tischfuß aus glänzendem Aluminium, Klemme oder Schraubbefestigung aus poliertem Aluminium. Verstellbare direkte Lichtverteilung. Tolomeo Video und Tolomeo Mini Video sind besonders für Bildschirmarbeitsplätze geeignet.

Farben: Tolomeo, Tolomeo mini, Tolomeo video: Aluminium oder Schwarz. Tolomeo micro: Aluminium, Schwarz, Rot, Anthrazitgrau, Türkis, Gelb, Bronze, Orange, Grün, Blau.

Estructura con brazo móvil de aluminio pulido, difusor orientable en todas direcciones en aluminio anodizado opaco, articulaciones y soportes de aluminio brillante. Sistema de equilibrado a muelles. Está disponible en cuatro versiones, cada una de las cuales viene con un soporte intercambiable: base de sobremesa de aluminio pulido y pinza o perno fijo para escritorio, de aluminio brillante. Emisión de luz directa y orientable, particularmente idónea cerca de las pantallas de los terminales (modelos Tolomeo video y Tolomeo mini video).

Colores: Tolomeo, Tolomeo mini, Tolomeo video: aluminio o negro. Tolomeo micro: aluminio, negro, rojo, gris ahumado, turquesa, amarillo, bronce, naranja, verde, azul.

tolomeo, tolomeo mini



aluminium black

tolomeo micro



aluminium black turquoise blue



red greyblue yellow bronze



orange green

tolomeo video, tolomeo mini video



aluminium black

A Tolomeo tavolo

Compasso d'Oro/ADI 1989 - Milano (Italia)

SNAI Oscar des Architectes d'Intérieur 1987 - Paris (France)

Haus Industrieform 1987 - Deutschland

Tolomeo micro:

Observateur du design 2001 - produit sélectionné - A.P.C.I. - Paris (France)

M Tolomeo tavolo:

Itinerario Storico Permanente - Museo Nazionale della Scienza e della Tecnica Leonardo da Vinci - Milano (Italia)

Sezione Design - Civica Galleria d'Arte Moderna - Gallarate (Italia)

The Israel Museum - Jerusalem (Israel)

Musée des Arts Décoratifs de Montréal - Montréal (Canada)

Museo Permanente del Design Italiano 1945/1990 - Triennale di Milano - Milano (Italia)

Galleria d'Arte Moderna - Roma (Italia)



table base

clamp

desk fixed support



tolomeo mini

tolomeo micro

tolomeo

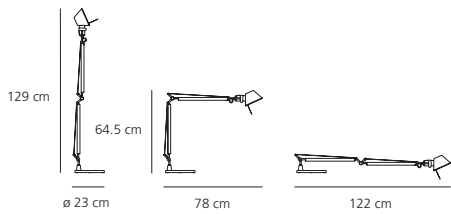

tolomeo, tolomeo fluo 18W

max 100W (E 27) - A 60

13W (G 24 d-1) - TC-D

max 50W/12V (GY 6,35) - QT 12 included

18W (G 24 q-2) - TC-DEL
included electronic ballast
and darklight louvre included

IP 20

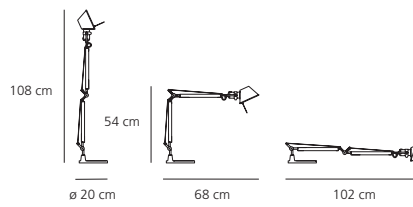

tolomeo mini, mini fluo 18W

max 100W (E 27) - A 60

13W (G 24 d-1) - TC-D

18W (G 24 q-2) - TC-TEL
included electronic ballast
and darklight louvre included

IP 20

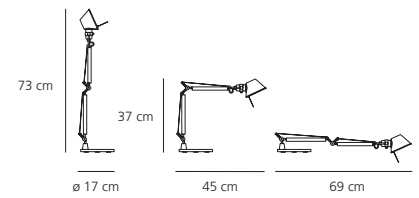

tolomeo micro

max 40W (E 14) - D 45 or

max 60W (E 14) - D 26

IP 20

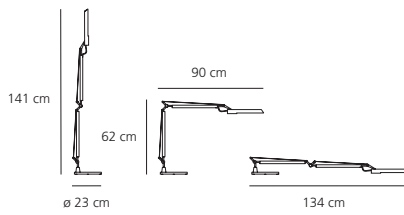

tolomeo video

11W (G 23) energy saving- TC -S

IP 20

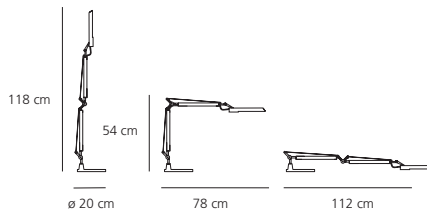

tolomeo mini video

11W (G 23) energy saving- TC -S

IP 20





tolomeo micro



tolomeo fluo 18W



tolomeo video

tolomeo micro led

design: michele de lucchi, giancarlo Fassina - 2006

Tolomeo micro, in versione LED, utilizza l'innovativa sorgente LED che fornisce una luce intensa e calda a bassi consumi. Struttura a bracci mobili in alluminio lucidato, diffusore orientabile in alluminio lucido e metacrilato satinato, snodi e supporti in alluminio brillantato. Sistema d'equilibratura a molle. Al corpo lampada può essere abbinata la base in alluminio lucidato, il morsetto o il perno per scrivania in alluminio brillantato. Emissione di luce diretta e orientabile.
Colore: alluminio.

Tolomeo Micro, LED version, uses the innovative LED light source that provides a warm, intense light with low energy consumption. Polished aluminium structure with movable arms, adjustable polished aluminium and satin methacrylate diffuser. Joints and supports in polished aluminium. System of spring balancing. The lamp unit can be used with interchangeable supports: table base, clamp or desk fixed support in polished aluminium. Direct and adjustable light emission.
Colour: aluminium.

Tolomeo Micro en version LED, utilise la nouvelle technologie à diodes en fournissant une lumière intense et chaude à basse consommation d'énergie. Structure à bras mobiles en aluminium poli, diffuseur orientable en aluminium brillant et méthacrylate satiné, articulations et supports en aluminium brillant. Système d'équilibrages à ressorts. Le corps de la lampe peut être associé à une base, à un étai ou à un pivot en aluminium poli. Emission de lumière directe et orientable.
Couleur : aluminium.

Tolomeo Micro – LED-Ausführung - mit innovativer LED-Lichtquelle für kräftiges, warmes Licht bei niedrigem Stromverbrauch. Rahmen mit verstellbaren Armen aus hochglanzpoliertem Aluminium, ausrichtbare Schirm aus hochglanzpoliertem Aluminium und satiniertem Metakryl, Gelenke und Halterungen aus poliertem Aluminium mit Federausgleichsystem. Erhältlich mit auswechselbaren Halterungen: Tischfuß aus glänzendem Aluminium, Klemme oder Schraubbefestigung aus poliertem Aluminium. Direkte und gestreute Lichtverteilung.
Farbe: Aluminium.

Tolomeo Micro, en la versión LED, incorpora la innovadora fuente de luz LED, para obtener una luz intensa y cálida a la vez, con un consumo energético mínimo. Estructura de brazos móviles de aluminio pulido, difusor orientable de aluminio pulido y metacrilato satinado; articulaciones y soportes en aluminio pulido. Sistema de equilibrado a muelles. Está disponible con soportes intercambiables: base de sobremesa de aluminio pulido y pinza o perno fijo para escritorio en aluminio pulido. Emisión directa y orientable.
Color: aluminio.

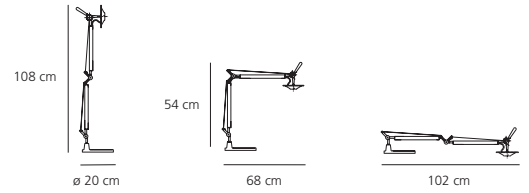

tolomeo micro led

1x5W LED

IP 20     +  touch dimmer

Attenzione: Luce bianca LED di classe 1M secondo EN60825-1. Potenza ottica massima emessa: 60 µW @450-470nm. Non osservare direttamente con strumenti ottici (lenti ecc.) e da una distanza inferiore a 20 cm.

Warning: White light LED in class 1M according to EN60825-1. Max optical power: 60 µW @450-470nm. Do not look at it directly with optical instruments (lenses etc.) and from a distance lower than 20 cm.

Attention: Lumière blanche LED de classe 1M selon EN60825-1. Puissance optique maximum émise: 60µW @450-470nm. Ne pas regarder directement avec des instruments optiques (lentilles, etc.) et à une distance inférieur de 20 cm.

Achtung: Weißes Licht LED von der Klasse 1M nach EN60825-1. Max optische Leistung: 60 µW @450-470nm Mit optischen Instrumenten (Linsen, usw.) nicht direkt und von einem Abstand höher als 20 cm ansehen.

Cuidado: Luz blanca LED de clase 1M según EN60825-1. Potencia óptica máxima emitida: 60 µW @450-470nm. No observar directamente con instrumentos ópticos (lentes etc.) y de una distancia inferior a 20 cm.





tolomeo basculante tavolo

design: michele de lucchi, giancarlo fassina - 2004



Struttura a bracci mobili in alluminio lucidato. Il diffusore in carta pergamena o in raso di seta supportato da materiale plastico, nel normale utilizzo, si dispone verticalmente, indipendentemente dall'angolazione del braccio. Snodi e supporti in alluminio brillantato. Sistema di equilibratura a molle. Disponibile con supporti intercambiabili: base tavolo in alluminio lucidato, morsetto o perno fisso per scrivania in alluminio brillantato. Emissione di luce diretta e diffusa.

Colore: grigio alluminio, alluminio lucido e ecrù o grigio alluminio.

Cantilevered structure in polished aluminium. The parchment paper or silk satin fabric on a plastic frame diffuser, normally used, remains vertical regardless of the angle of the arm. Joints and supports in polished aluminium. System of spring balancing. Available with interchangeable supports: table base, clamp or desk fixed support in polished aluminium. Direct and diffused light emission.

Colour: aluminium grey, polished aluminium and ecrù or aluminium grey.

Structure à bras articulé en aluminium poli. Le diffuseur en papier parchemin ou en polycarbonate recouvert de satin de soie, dans le cadre d'une utilisation normale, se place verticalement, indépendamment de la position du bras. Rotules et supports en aluminium brillant. Système d'équilibrage à ressorts. Disponible avec accessoires interchangeables: base ronde en aluminium poli, étau ou pivot en aluminium poli. Emission lumineuse directe et diffuse.

Couleurs: gris aluminium, aluminium poli et écrù ou gris aluminium.

Ausrichtbare Arme aus glänzendem Aluminium. Der Schirm aus Pergamentpapier oder Seidensatin besteht bei normalem Gebrauch vertikal, unabhängig von der Ausrichtung des Armes. Gelenke und Halterungen aus poliertem Aluminium mit Federausgleichsystem. Erhältlich mit auswechselbaren Halterungen: Tischfuß aus glänzendem Aluminium, Klemme oder Schraubbefestigung aus poliertem Aluminium. Direkte und gestreute Lichtverteilung.

Farben: Aluminiumgrau, glänzendes Aluminium und Ecrù oder Aluminiumgrau.

Estructura con brazo móvil en aluminio pulido. Difusor en pergamino o en raso seda reforzado con plástico, en su uso normal, se dispone verticalmente, independientemente de la angulación del brazo. Articulaciones y soportes en aluminio pulido. Sistema de equilibrado a muelles. Está disponible con soportes intercambiables: base de sobremesa de aluminio pulido y pinza o perno fijo para escritorio en aluminio pulido. Emisión directa y difusa.

Colore: gris aluminio, aluminio pulido y ecrù o gris aluminio.

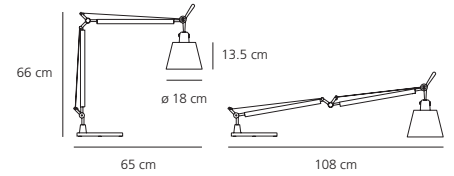

tolomeo tavolo basculante

max 60W (E 27) - A 60 or 

max 100W (E 27) - QT 32 

IP 20    



silk satin fabric

parchment paper





tolomeo mega morsetto

design: michele de lucchi, giancarlo fassina - 2004



Struttura a bracci mobili in alluminio lucidato, diffusore orientabile in tutte le direzioni in carta pergamena o in raso di seta supportato da materiale plastico, disponibile in tre dimensioni. Snodi e supporti in alluminio brillantato. Sistema di equilibratura a molle. Morsetto in alluminio brillantato. Emissione di luce diretta orientabile.
Colori: alluminio lucido/écru o alluminio lucido/grigio alluminio.

Cantilevered arms in polished aluminium, diffuser available in three sizes, in parchment paper or in silk satin fabric on a plastic frame may be rotated in all directions. Joints and supports in polished aluminium. System of spring balancing. Polished aluminium clamp. Direct adjustable light emission.
Colours: polished aluminium/écru or polished aluminium/aluminium grey.

Structure: bras articulés en aluminium poli. Diffuseur: orientable dans toutes les directions, en papier parchemin ou en polycarbonate recouvert de satin de soie, disponible en trois tailles. Articulations et supports en aluminium brillant. Système d'équilibrage à ressorts. Etau en aluminium brillant. Emission lumineuse directe orientable. Couleurs: aluminium poli/écru ou aluminium poli/gris aluminium

Ausrichtbare Arme aus glänzendem Aluminium, in alle Richtungen verstellbarer Leuchtenkopf aus mit Kunststoff stabilisiertem Pergamentpapier oder Seidensatin, erhältlich in drei Größen. Gelenke und Halterungen aus poliertem Aluminium mit Federausgleichsystem. Klemme aus poliertem Aluminium. Verstellbare direkte Lichtverteilung.
Farben: glänzendes Aluminium/Écru oder glänzendes Aluminium/Aluminiumgrau.

Estructura con brazos móviles de aluminio pulido, difusor orientable en todas direcciones en pergamino o en raso seda reforzado con plástico, disponible en tres tamaños. Articulaciones y soportes de aluminio pulido. Sistema de equilibrado a muelles. Pinza de aluminio pulido. Emisión de luz directa orientable.
Colores: aluminio pulido/gris o aluminio pulido/gris aluminio.

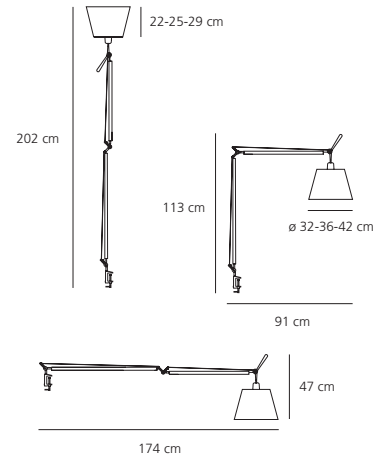

tolomeo mega morsetto

max 150W globe ø cm 12 (E 27) - G 120 or 

max 150W (E 27) - QT 32 

switch on-off on body lamp

IP 20    

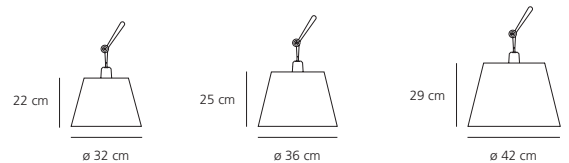

silk satin fabric

parchment paper

